

# NYX650/660 ToF Camera Specification



# Table of Contents

1 General Information .....	4
1.1 Terms of Use.....	4
2 Precautions .....	5
2.1 Safe Usage Instructions .....	5
2.2 Power.....	5
2.3 Usage .....	5
2.4 Temperature .....	6
3 Specifications and Requirement .....	7
3.1 General Specifications.....	7
3.2 Electrical Specifications .....	8
3.2.1 Recommended Operating Conditions.....	8
3.2.2 Power Consumption .....	8
3.2.3 Absolute Maximum Ratings .....	8
3.3 NYX650 Dimension .....	9
3.4 NYX660 Dimension .....	10
3.5 Optical Specifications.....	11
3.5.1 Field of View .....	11
3.6 Working Condition Requirements .....	11
3.6.1 Hardware Requirements .....	11
3.6.2 Software Requirements.....	11
3.6.3 Environmental Requirements .....	12
3.6.4 Coordinate of the Camera System .....	12
4 Interface with Host .....	13
4.1 NYX650 Interface .....	13
4.2 NYX660 Interface .....	14
4.3 LED Indication .....	15
5 Installation .....	16
5.1 Hardware Installation .....	16
5.1.1 NYX650 Installation Steps.....	16
5.1.2 NYX660 Installation Steps.....	16
5.1.3 POE Mode Installation (NYX660).....	17
5.2 ScepterSDK .....	17
5.2.1 FrameViewer(OpenCVSample).....	17
5.3 ScepterGUITool.....	17
5.4 Default IP address.....	17
5.5 DHCP to obtain IP .....	18
5.6 Firmware Upgrade.....	18
6 Features.....	19
6.1 Hardware Trigger Mode .....	19
6.2 Software Slave Trigger Mode.....	20
6.3 Exposure Time Configuration .....	20
6.3.1 Manual Exposure.....	20
6.4 Data Filtering .....	20
6.5 IR Image .....	21
6.6 RGBD Map.....	21
6.6.1 ColorImgToDepthSensor.....	21

6.6.2 DepthImgToColorSensor ..... 22

7 NYX650/660 Accessories and Package ..... 23

8 Appendix..... 25

    8.1 RoHS Compliance ..... 25

    8.2 Laser Specification ..... 25

    8.3 FCC Statement..... 25

9 Revision History ..... 27

# 1 General Information

The purpose of this document is to familiarize the customer with the correct operation of the ToF NYX650/660 products. This document provides important information about the camera's features, hardware specification, safe use of the camera, and installation procedures.

Model	Enclosure Rating	PoE+	RGB
NYX650	IP42	No	Yes
NYX660	IP67	Yes	Yes

NYX650 can only be powered by DC power and IP42 rating.

While NYX660 can be powered either by DC power or Power over Ethernet, and IP67 rating enclosure to resist dust and water.

## 1.1 Terms of Use

We offers a 1-year-warranty for the NYX650/660 products.

### Warranty Information

Please do follow the guidelines below when using the ToF camera.

#### Do not remove the product's serial number label

Warranty will be void, if the label is damaged or removed and the serial number can't be read from the camera's registers.

#### Do not disassemble the product housing

Do not disassemble the housing. Touching any internal components may damage the products.

**Prevent any objects or substances from entering the product housing, otherwise the product may fail or damaged.**

#### Avoid electromagnetic areas

Do not use the camera near strong electromagnetic areas. Prevent the product from electrostatic charging.

#### Transport in original packaging

Transport and store the camera in its original packaging only. Suggest not to discard the packaging.

#### Clean with care

If you have to clean the housing of the camera, follow the guidelines in the notice as below:



- Use a soft, dry cloth that won't generate static during cleaning;
- To remove tough stains, use a soft cloth dampened with a small amount of neutral detergent (Pure water or alcohol), after that wipe dry;
- Make sure no any residual detergent after cleaning, before reconnecting the camera to power.

#### Read the manual

Do read the manual carefully before using the camera.

## 2 Precautions

### 2.1 Safe Usage Instructions

	<b>DANGER</b>
	<p><b>Electric Shock Risk</b></p> <p>Non-standard and improper power supplies may result in fire and electric shock. You must confirm the camera power supply used that meets the absolute specification of voltage and current.</p>
	<b>CAUTION</b>
	<p><b>Invisible Radiation</b></p> <p>This camera uses laser to work, improper use may damage the eye. Lasers are classified as risk group 1 (low risk) according to EN 60825 which means that the product presents no risk related to exposure limits under normal usage conditions. Eye safety is only guaranteed when the camera is used properly.</p>

### 2.2 Power

NYX650 can only work with external DC power;

NYX660 can work with either Power over Ethernet or external DC power.

The DC power can accept 11V~26V power source. For higher than 28V or lower than 11V, the device shall not work well or even be damaged.

For PoE power source, the PSE device shall apply the PoE+ standard (802.3at) or above, lower than that may cause the product doesn't work well or even be damaged.

We doesn't produce PoE injector, but we can purchase it from 3<sup>rd</sup> party and ship to customer at original cost. Below is the PoE+ injector available vendor list.

Vendor	Model Number
H3C	EWPAM2NPOE+
TP LINK	TL-PoE+170S

### 2.3 Usage

1. Don't try to open the camera housing. Each camera has been calibrated at the factory to achieve precise measurements. Touching internal components may damage the camera and cause calibration data lost.

2. Incorrect plugging in and unplugging of the camera's power cable can damage the camera. To avoid

switch-on surges damaging the camera, please plug in the power cable into the camera's power connector firstly before getting power source on.

3. Don't try to change the position of the lens, may cause damage to the camera.
4. Do store the camera carefully when not in use, in original package the best.

## 2.4 Temperature

To avoid damaging the camera and to achieve best performance, please observe the maximum and minimum housing temperatures in Section 3.1

## 3 Specifications and Requirement

### 3.1 General Specifications

Specification	NYX650	NYX660
Technology	ToF (Time-of-flight) Depth Camera	
Depth Sensor Resolution and Frame rate	640 x 480@30FPS	
Depth Sensor Field of View	H-70° V-50°	
RGB Sensor Resolution and Frame rate	1600*1200@30fps	
RGB Sensor Field of View	H-70° V-50°	
Output Formats	16bit (Depth) + 8bit (IR) + JPEG (RGB)	
Use Range	0.3m ~ 4.5m*	
Accuracy	<2%*	
Power Consumption	Average Max. 6W(Ref)	
Illumination	940nm, 2 x 6W Optical Power VCSEL	
Dimension(L*H*W)	125mm*50mm*34.5mm	131.3mm*50mm*44.5mm
Weight	256g	326g
Power Supply	DC power	PoE+ or DC power
Interface	Gigabit Ethernet	
Digital I/O(Synchronization)	1in, Passive Sync Signal	
Enclosure Rating	IP42	IP67
Working/Storage Temperature	-20°C -50°C / -30°C -70°C	
Software	C/C++ /Python/C #/ROS1/ROS2	
Operation System	Windows 7/8/10/11, Linux, Arm Linux	
Cooling	Passive, no fan	
Certification	FCC/CE/FDA	
Eye safety	Class 1	

\*Accuracy error and Use Range vary with the reflectivity of the measured object

## 3.2 Electrical Specifications

### 3.2.1 Recommended Operating Conditions

Parameter	Symbol	Min	Typ.	Max	Units
DC Power	VDD	11	12	26	V
Digital I/O (Ext_Trigger)	Vin	3.3		24	V
Operating Temperature	Ta	-20		50	°C
Storage temperature		-30		70	°C
Operating humidity		20		80	%
Storage humidity		20		80	%

### 3.2.2 Power Consumption

Parameter	Model	Conditions	Average	Max	Units
Active Mode	NYX650/660	30fps@5500μs	470	640	mA
Broadcast Mode	NYX650/660		190	200	mA

Note: 12V input voltage

### 3.2.3 Absolute Maximum Ratings

This is a stress rating only and functional operation of the devices at those or any other conditions above those indicated in the operation listings of this specification is not promised. Exposure to maximum rating conditions for extended periods may affect device reliability.

Parameter	Symbol	Min	Typ.	Max	Units
DC Power	VDD	11	12	28	V
Digital I/O (Ext_Trigger)	Vin	-0.3		24	V
Operating Temperature	Ta	-20		50	°C



### 3.3 NYX650 Dimension

This drawing contains information about the dimensions and user mounting location of NYX650.

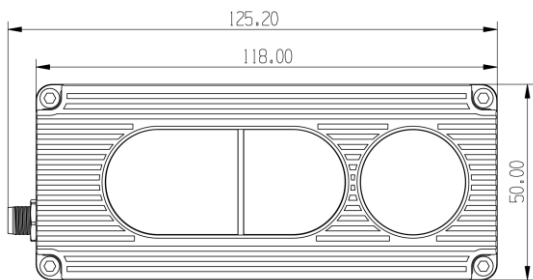

Front View

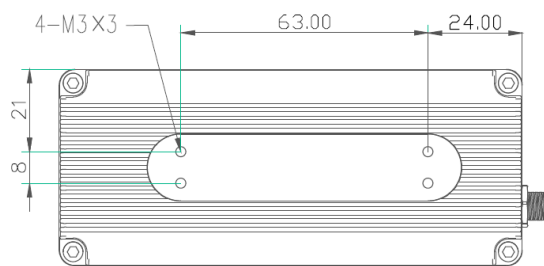

Back View

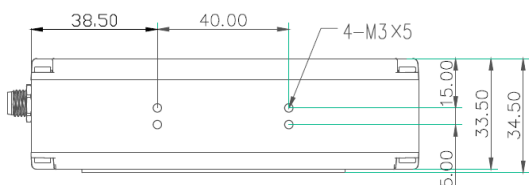

Bottom View



Top View

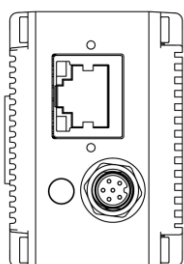

Left View

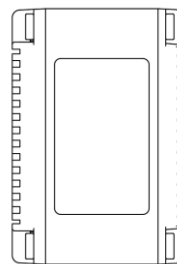

Right View

Fig. 3.1: ToF Camera Dimensions (Unit: mm)

### 3.4 NYX660 Dimension

This drawing contains information about the dimensions and user mounting location of NYX660.

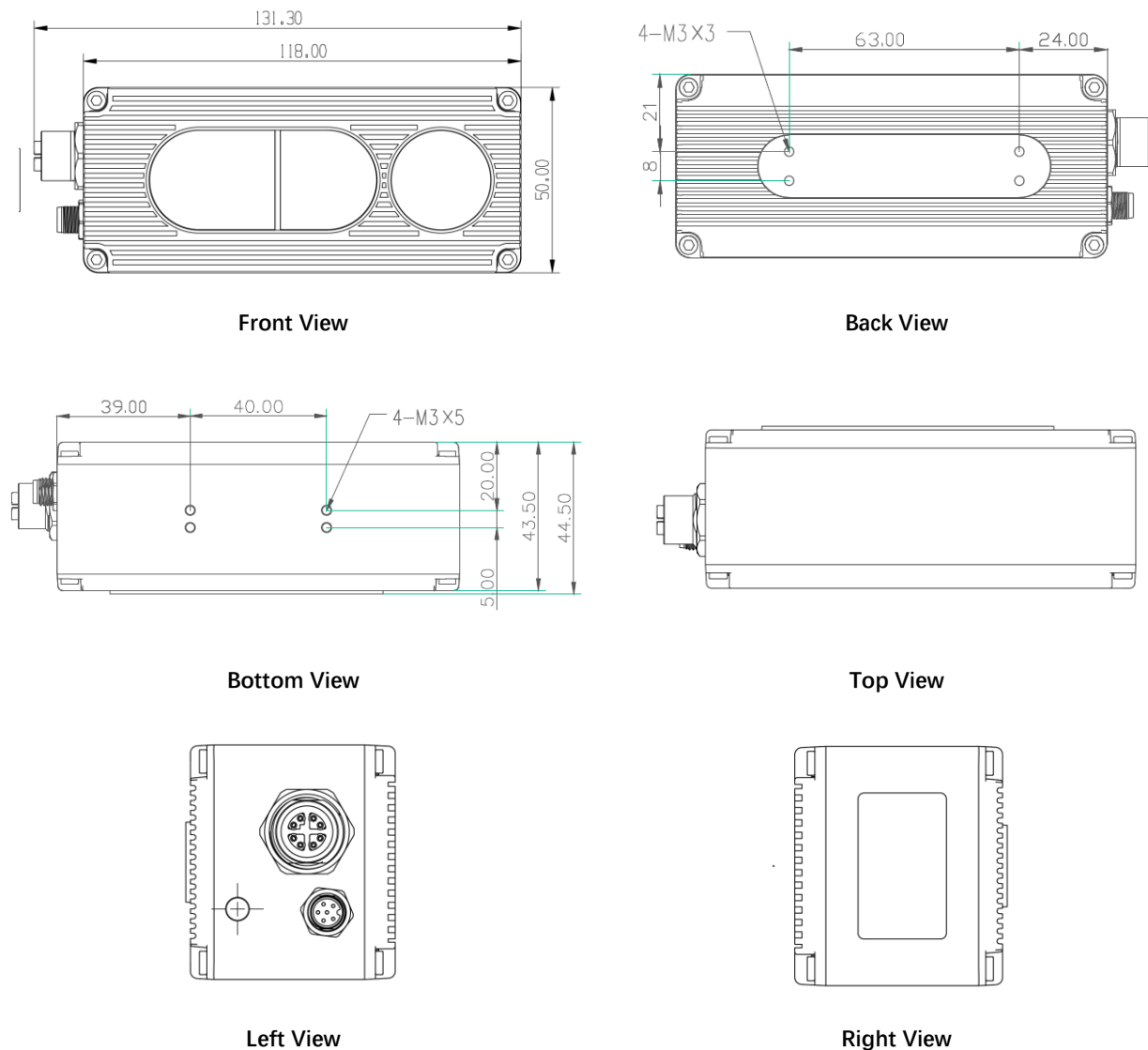
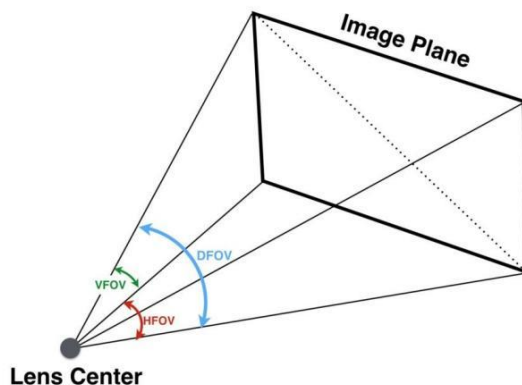

Fig. 3.2: ToF Camera Dimensions (Unit: mm)

## 3.5 Optical Specifications

### 3.5.1 Field of View



The field of view refers to the view angle of the ToF products. The ToF sensor's aspect ratio is 4:3, typically the horizontal field of view is larger than the vertical field of view. The typical field of view of NYX650/660 is H-70° and V-50°.

## 3.6 Working Condition Requirements

### 3.6.1 Hardware Requirements

NYX650:

- CAT5e Ethernet cable (CAT6 Included in package)
- M8 A CODE Multiple Functional cable (Included in package)

NYX660:

- M12 X CODE CAT6a Ethernet cable (Included in package)
- M8 A CODE Multiple Functional cable (Included in package)

Or

- PoE+ Power Supplier (Not included in package)

### 3.6.2 Software Requirements

Operating system:

- 32-bit Windows 7/10/11
- 64-bit Windows 7/10 (recommended)/11
- Linux (x86, x64)

### 3.6.3 Environmental Requirements

Housing temperature during operation:	-20–50 °C
Humidity during operation:	20–80 %, relative
Storage temperature:	-30–70 °C
Storage humidity:	20–80 %, relative

### 3.6.4 Coordinate of the Camera System

There are two coordinate system need to be understood, one is camera coordinate system (CCS), one is world coordinate system (WCS).

CCS: CCS describe the two-dimensional data, the origin of coordinates is the optic center.

WCS: WCS describe the three-dimensional information.

The CCS data can switch to the WCS data using the camera internal parameters.

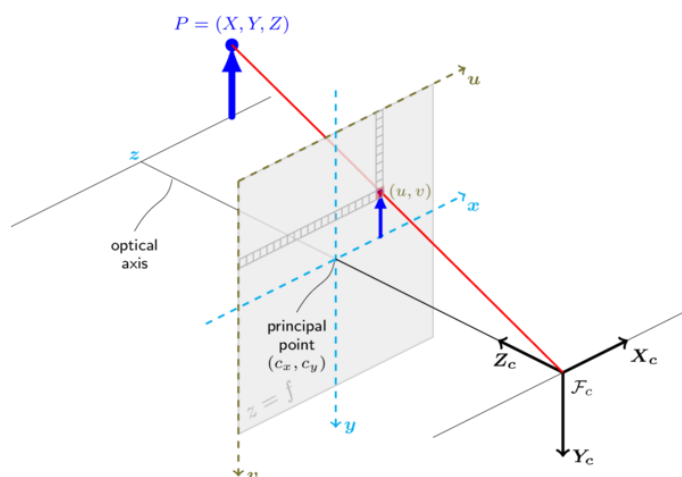

The origin of the coordinate system is defined as the below figure shows:

1. X coordinate locates 25mm from the top edge of the camera.
2. Y coordinate locates 52.3mm from the right edge of the camera.
3. Z coordinate is zero offset at the front of the surface of lens.

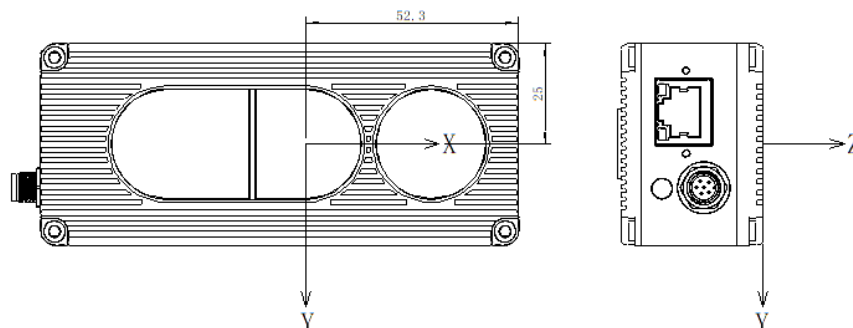

MeshLab and CloudCompare tools are recommended to analyze the point cloud data saved by ScepterGUITool or ScepterSDK.

## 4 Interface with Host

### 4.1 NYX650 Interface

NYX650 is equipped with RJ45, M8 A CODE Multiple Functional Interface as shown in below figure. For more information about pin assignments and connector types, see the following sections.

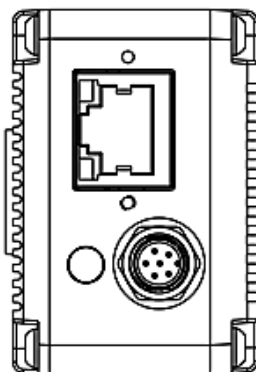

### M8 A CODE Multiple Functional Interface

	Pin	Line Color	Designation
	1	BLACK	GND
	2	RED	VCC
	3	WHITE	Ext_Trigger
	4	YELLOW	NC
	5	BLACK	GND
	6	BLUE	IP RESET
Pin	Designation	Direction	Description
1.5	GND	GND	GND
2	VCC	Power	DC 12-24V
3	Ext_Trigger	INPUT	External trigger input (3.3V-24V)
6	IP RESET	INPUT	Pull high (3.3V-24V) for 10 seconds then the IP is reset as 192.168.1.101.

## 4.2 NYX660 Interface

NYX660 is equipped with two aviation connectors (M12 X CODE and M8 A CODE) as shown in below figure. When connected to cables with IP67 protection, the product can achieve an IP67 level. When the device is powered by POE, installing an IP67 waterproof plug on the M8 A CODE Multiple Functional Interface allows the product to maintain an IP67 level.

For more information about pin assignments and connector types, see the following sections.

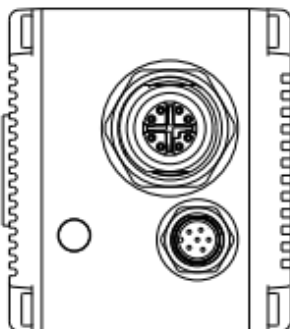

### M8 A CODE Multiple Functional Interface

	Pin	颜色	Designation
	1	黑色	GND
	2	红色	VCC
	3	白色	Ext_Trigger
	4	黄色	NC
	5	黑色	GND
	6	蓝色	IP RESET
Pin	Designation	Direction	Description
1.5	GND	GND	GND
2	VCC	Power	DC 12-24V
3	Ext_Trigger	INPUT	External trigger input (3.3V-24V)
6	IP RESET	INPUT	Pull high (3.3V-24V) for 10 seconds then the IP is reset as 192.168.1.101.

### M12 X CODE Ethernet Interface

	Pin	Designation	Designation
	1	TX_D1+	Tranceive Data+
	2	TX_D1-	Tranceive Data-
	3	RX_D2+	Receive Data+
	4	RX_D2-	Receive Data-
	5	BI_D4+	Bi-directional Data+
	6	BI_D4-	Bi-directional Data-
	7	BI_D3-	Bi-directional Data-
	8	BI_D3+	Bi-directional Data+

## 4.3 LED Indication

An LED at the back side of the camera indicates the camera status.

The LED animation table is shown as below:

1. Ethernet Broadcast, no connection established, BLUE LED blinking repeatedly.



2. Ethernet connection established, BLUE LED constantly on.



3. IP RESET, Press the IP RESET button for 5 seconds, PURPLE LED is on for 5 seconds and blink twice then the product reset itself.



4. Firmware Upgrade, RED LED is on until firmware upgrade finished.



# 5 Installation

## 5.1 Hardware Installation

You have read and understood the warnings listed under "Precautions" on Chapter 2;

To achieve reliable distance measurements, please follow below tips:

- Better not using the camera in strong sunlight. If have to, keep the ambient light below 100k Lux.
- Do NOT place any objects in the scene that are not part of your intended target, especially mirrors or other shiny surfaces/objects.
- Maintain a stable housing temperature during operation.
- Take measures to provide cooling to camera.
- Mount the camera robustly.
- All accessories are ready.

### 5.1.1 NYX650 Installation Steps

NYX650 product transmits the required data to host by Ethernet cable, and it doesn't support Power over Ethernet, so the power adaptor shall be used.

The steps are as below:

1. Mount the camera in an appropriate fixture, e.g., a camera bracket.
2. Connect the NYX650 ToF camera to the host processor with the Ethernet cable.
3. Insert the DC connector of the power supply adaptor into the Multiple Functional Interface of the camera.
4. Connect the adaptor to power source.
5. Please do set the IP address of the camera and host PC in the same segment.
6. The default IP address of NYX650 is 192.168.1.101, you can change the IP address by the ScepterGUITool.

Please do read the document before reconfiguring the camera.

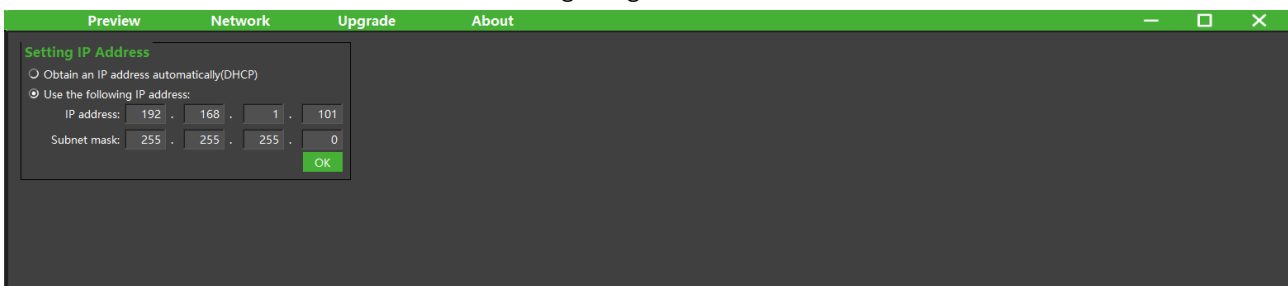

### 5.1.2 NYX660 Installation Steps

The steps are as below:

1. Mount the camera in an appropriate fixture, e.g., a camera bracket.
2. Connect the NYX660 ToF camera to the host processor with the M12 X CODE CAT6a Ethernet cable.
3. Insert the DC connector of the power supply adaptor into the Multiple Functional Interface of the camera.
4. Connect the adaptor to power source.



5. Please do set the IP address of the camera and host PC in the same segment.
6. The default IP address of NYX660 is 192.168.1.101, you can change the IP address by the ScepterGUITool.

### 5.1.3 POE Mode Installation (NYX660)

The steps are as below:

1. Mount the camera in an appropriate fixture, e.g., a camera bracket.
2. Plug one end of the Ethernet cable into the M12 X CODE CAT6a Ethernet Interface of the camera, and plug the RJ45 end into the Ethernet port of your PoE switch or PoE injector.
3. Connect the PoE switch or PoE injector to your host processor by Ethernet cable.
4. Connect the PoE switch or PoE injector to power source.

## 5.2 ScepterSDK

ScepterSDK is a cross platform software development kit. It can support VENO86/87 and contains multiple versions on different operation systems, including Windows, Linux, Arm Linux, ROS, ROS2, Python, C# etc.

Download or clone SDK project from our GitHub:

<https://github.com/ScepterSW/ScepterSDK>

### 5.2.1 FrameViewer(OpenCVSample)

FrameViewer(OpenCVSample) is an open source application in SDK project that can guide user how to call the SDK APIs. It has a pre-build version app in PrecompiledSamples folder, the source code is in Samples/OpenCV folder. See the document for the details.

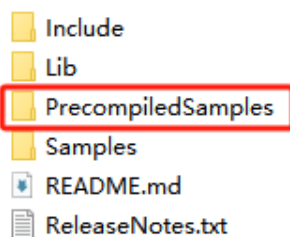

## 5.3 ScepterGUITool

ScepterGUITool is a graphic tool on Windows and Ubuntu for NYX650/660.

Download or clone ScepterGUITool from our GitHub:

<https://github.com/ScepterSW/ScepterGUITool>

## 5.4 Default IP address

The default IP address of the NYX650/660 is 192.168.1.101, if you want to set the IP with others or enable DHCP method, please use ScepterGUITool to change the default setting:

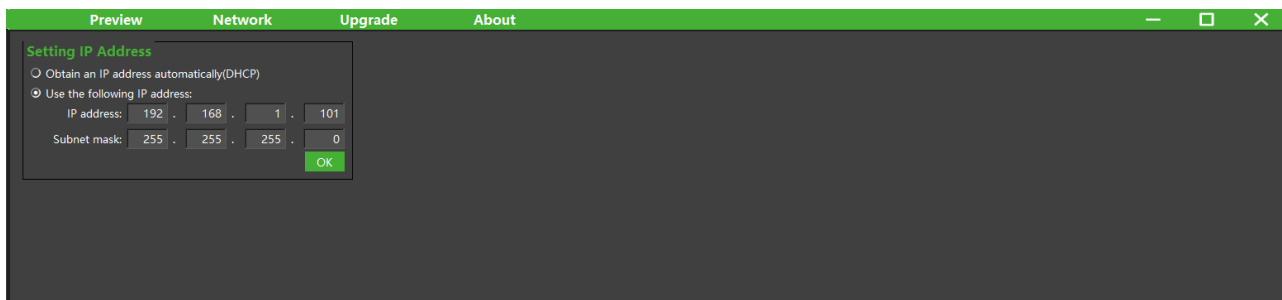

## 5.5 DHCP to obtain IP

The product IP can be set to be obtained through DHCP, and the product needs to be connected to a server network that supports DHCP, such as a router:

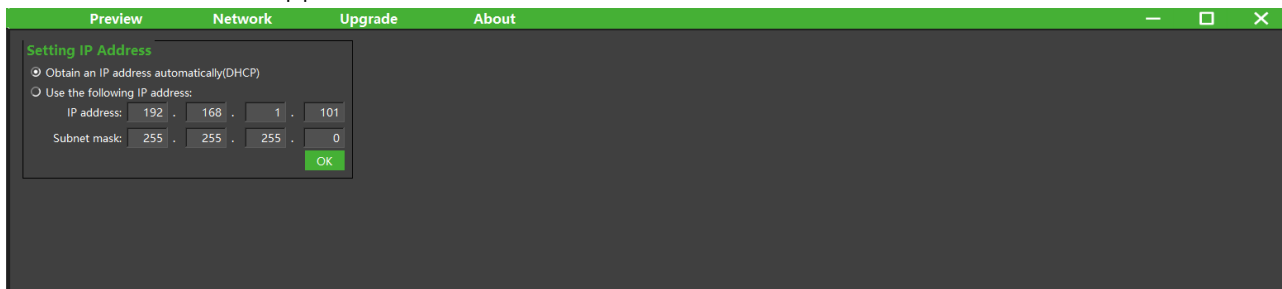

## 5.6 Firmware Upgrade

The user can use ScepterGUITool to upgrade the firmware of the NYX650/660:

1. Click "" and select the path where the firmware is located.
2. Click the "Upgrade" button and wait for the upgrade.
3. Progress bar to "100%" upgrade is complete, wait for the camera to reboot.

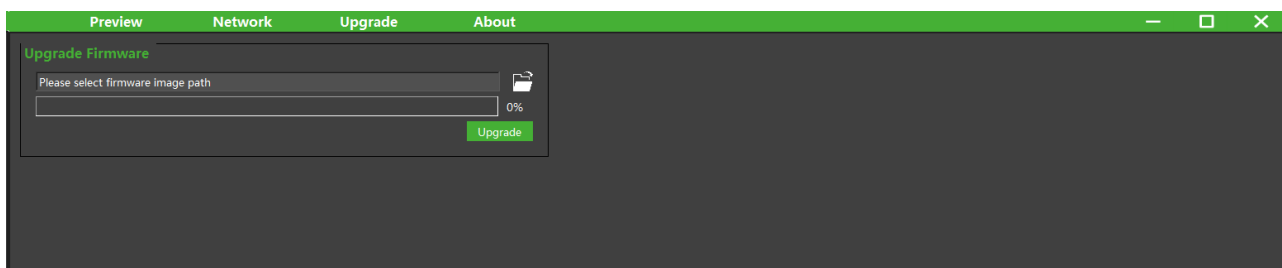

## 6 Features

### 6.1 Hardware Trigger Mode

At Hardware slave trigger mode, NYX650/660 products will wait for the hardware trigger signal on Ext\_Trigger by default, and will not start a frame of exposure until a valid hardware trigger pulse is received on the Ext\_Trigger pin. Once the exposure is over, the product goes back to waiting for the trigger.

**Step 1:** set NYX650/660 product as hardware slave trigger mode by a software API. Please refer to the sample code of NYX650/660 hardware slave trigger mode.

**Step 2:** Feed the NYX650/660 with a correct hardware trigger signal.

1. External input trigger signal voltage should range 3.3V-24V.
2. Driving current ability should be more than 5mA.
3. It is recommended to add a hardware debounce circuit on the Ext\_Trigger line.
4. The requirement to T1 should be above 1ms.
5. By default, the hardware trigger is rising edge activated, please refer to the following figure:

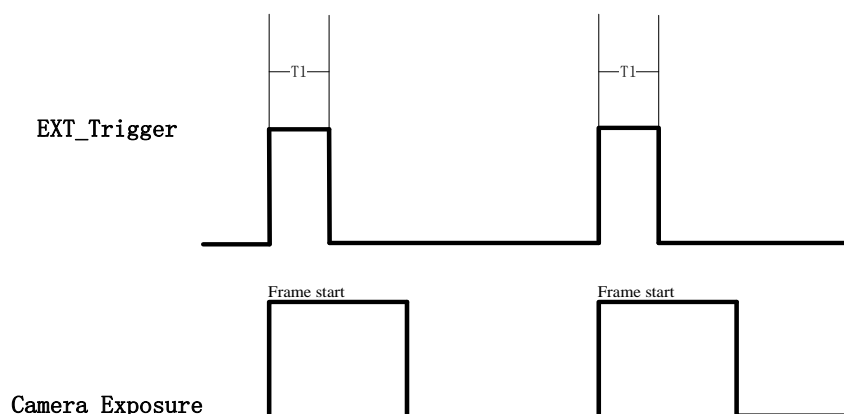

You can configure the hard trigger signal parameters through ScepterGUITool. The signal parameters are configured on the Device Settings page, as shown in the following figure:

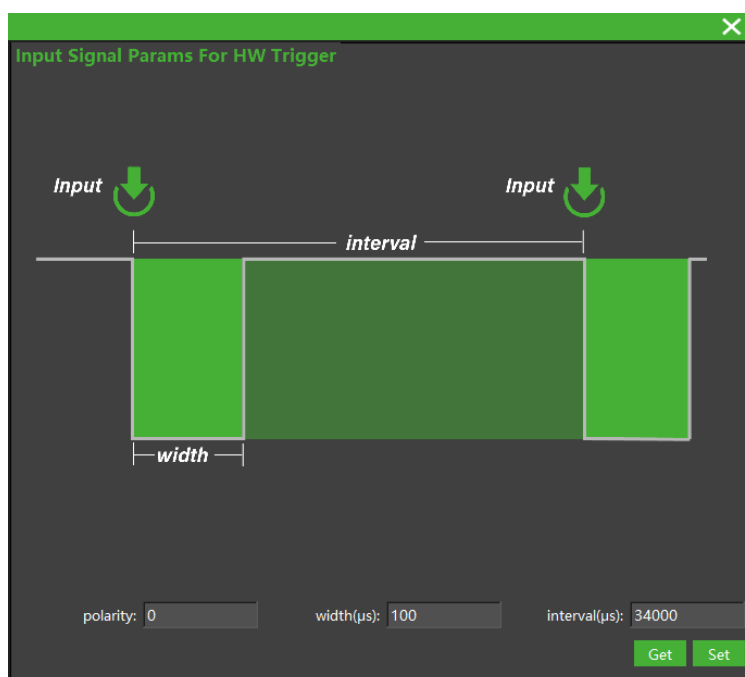

**Input signal Params For HW Trigger:**

1) polarity: signal validity detection polarity. 0 is active low and 1 is active high.

Value Range: [0, 1]

2) width: signal width validity detection, signal less than the width setting will not respond. 16-bit, in  $\mu$ s.

Value Range: [1, 65535]

3) interval: continuous signal interval validity detection, no response to signal less than interval setting.

Value Range: [34000, 65535]

**6.2 Software Slave Trigger Mode**

At software slave trigger mode, NYX650/660 product outputs image only at every trigger API call.

**Step 1: set NYX650/660 product as software slave trigger mode by a software API.**

**Step 2: Call the API of software trigger to issue a frame start.**

Please refer to the sample code of NYX650/660 software slave trigger mode.

**6.3 Exposure Time Configuration****6.3.1 Manual Exposure**

The user can set NYX650/660 product at manual exposure mode, with a fixed exposure time. The value of maximum exposure time depends on the frame rate.

Frame rate(fps)	Maximum exposure time( $\mu$ s)	Frame rate(fps)	Maximum exposure time( $\mu$ s)
1	122000	16	13000
2	115000	17	12000
3	77000	18	11000
4	57000	19	10500
5	45000	20	10000
6	37000	21	9500
7	32000	22	9000
8	27000	23	8000
9	24000	24	8000
10	22000	25	7500
11	20000	26	7000
12	17000	27	7000
13	16000	28	6500
14	15000	29	6000
15	14000	30	5500

**6.4 Data Filtering**

In the software SDK, we implemented data filtering to improve the depth data performance.

The filtering algorithm includes:

- FillHole
- Spatial Filter

- Time Filter
- Flying Pixel Filter
- Confidence Filter

## 6.5 IR Image

Besides the depth image, NYX650/660 camera can also output a VGA resolution IR image. And the IR image is exactly timing synchronized with the depth image. Pixel to pixel mapping is also exactly aligned.

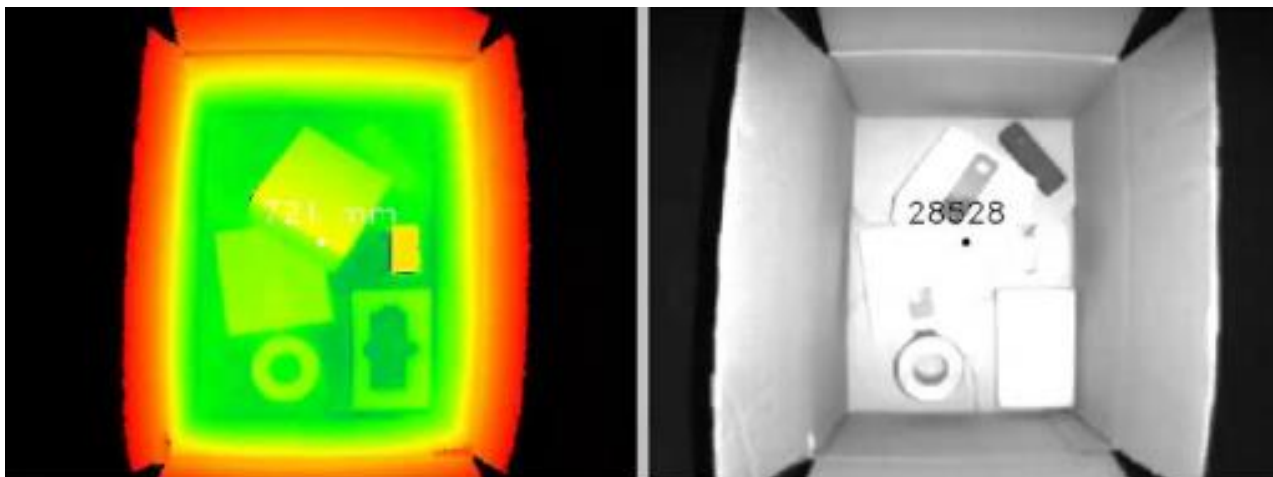

## 6.6 RGBD Map

NYX650/660 camera support RGBD Map function.

### 6.6.1 ColorImgToDepthSensor

RGB image map to Depth domain. When enabled, images with RGB pixels map to Depth pixel space are output and displayed, that is, RGB images corresponding to depth pixels one by one.

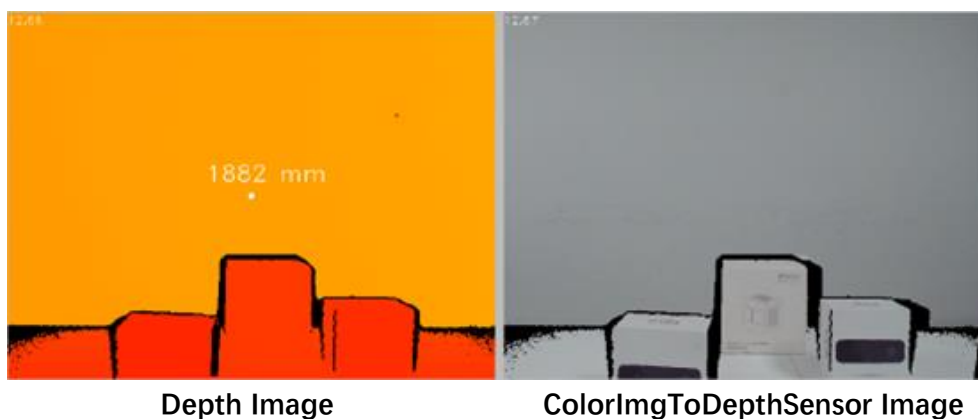

## 6.6.2 DepthImgToColorSensor

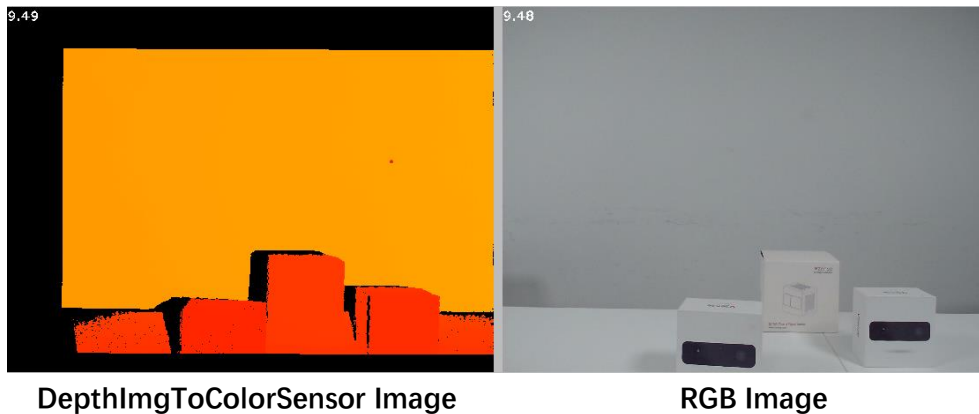

Depth image map to RGB domain. When enabled, the images with Depth pixels aligned to the RGB pixel space are output and displayed, that is, the depth image corresponding to RGB pixel one by one.



## 7 NYX650/660 Accessories and Package

In package item list:

NYX650

Part No.	Description	Picture		
NYX650	NYX650 Depth Camera Module			
314000309438	- CAT6 Ethernet Cable, 23AWG 4 Pair, Shielded Twisted Pair - Cord Length: 3m			
314000309436	- M8 A CODE 6PIN Multiple Functional Cable			
	- Cord Length: 2m			
	No.	Color	Wire Gauge	Signal
	1	BLACK	22AWG	GND(Power GND)
	2	RED	22AWG	DC 12-24V
	3	WHITE	28AWG	EXT_TRIGGER
	4	YELLOW	28AWG	NC
5	BLACK	28AWG	GND(Signal GND)	
6	BLUE	28AWG	IP RESET	
UGNYX650	NYX650 User guide			

**NYX660**

Part No.	Description	Picture		
NYX660	NYX660 Depth Camera Module			
314000309437	-M12 X CODE CAT6a Ethernet Cable, 24AWG 4 Pair, shielded Twisted Pair -Aviation Connector to RJ45 -Cord Length: 3m			
314000309436	-M8 A CODE 6PIN Multiple Functional Cable			
	-Cord Length: 2m			
	No.	Color	Wire Gauge	Signal
	1	BLACK	22AWG	GND(Power GND)
	2	RED	22AWG	DC 12-24V
	3	WHITE	28AWG	EXT_TRIGGER
	4	YELLOW	28AWG	NC
5	BLACK	28AWG	GND(Signal GND)	
6	BLUE	28AWG	IP RESET	
UGNYX660	NYX660 User guide			

You can ask we to do customization to the cable for any reason, for example extending the cable length. Please do NOT use the accessories from other parts except our Company, otherwise warranty will void.

**Optional item list:**

Item	Component	Description	Quantity
1	H3C EWPAM2NPOE+	802.3at PoE Injector	1
2	TP LINK-PoE+170S	802.3at PoE Injector	1

Optional items need customer to pay for.



## 8 Appendix

### 8.1 RoHS Compliance

This product complies with the limits of Pb, Hg, Cd, Cr (VI), PBB, PBDE, DEHP, BBP, DBP, DIBP as set by RoHS Directive (EU)2015/863 amending Annex II to Directive 2011/65/EU.

### 8.2 Laser Specification



Use of controls or adjustments or performance of procedures other than those specified herein may result in hazardous radiation exposure.

**Complies with 21 CFR 1040.10 and 1040.11 except for conformance with**

**IEC 60825-1 Ed.3**

The following Class1 laser label is located on the bottom of the sensor.



### 8.3 FCC Statement



This equipment has been tested and found to comply with the limits for a Class A digital device, pursuant to part 15 of the FCC Rules. These limits are designed to provide reasonable protecti

on against harmful interference when the equipment is operated in a commercial environment. This equipment generates, uses, and can radiate radio frequency energy and, if not installed and used in accordance with the instruction manual, may cause harmful interference to radio communications. Operation of this equipment in a residential area is likely to cause harmful interference in which case the user will be required to correct the interference at his own expense.

